

ITALIA
CAPOLAVORO
Amore mio



A N T I P A S T I

***Selezione di bruschette,
salumi e formaggi tipici italiani***

*A selection of bruschetta,
cold meats and typical Italian cheeses*

*Selección de bruschette,
embutidos y quesos típicos italianos*

19

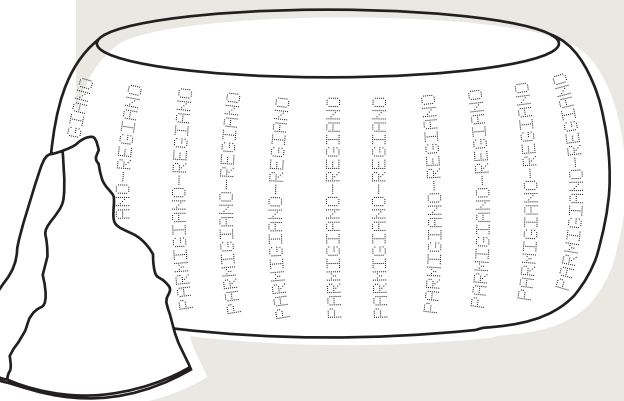

AFFETTATI AL MOMENTO

VITELLO TONNATO

*Carne di vitello con crema di tonno,
capperi e acciughe*

*Beef with creamed tuna,
capers and anchovies*

*Carne de ternera con cremoso de atún,
alcaparras y anchoas*

20

CARPACCIO DI VITELLO

*Filetto di vitello invecchito,
croccante di carciofi, scaglie di
parmigiano e olio di basilico*

*Fillet of fattened beef,
crispy artichoke, Parmesan cheese
shavings and basil oil*

*Solomillo de ternera cebón, crujiente de
alcachofa, lascas de queso parmesano y
aceite de albahaca*

22

CARPACCIO DI ZUCCHINI

*Zucchine tagliate sottili, pinoli tostati,
parmigiano grattugiato e pesto*

*Shredded courgette, toasted pine-nuts,
grated Parmesan cheese and pesto sauce*

*Calabacín finamente cortado, piñones
tostados, queso parmesano rallado
y salsa pesto*

17

I N S A L A T E

LA CESARE

Lattuga romana, pomodori al naturale, croccante di pollo, crostini di pane, uovo sodo, Parmigiano, mais e salsa Caesar

Romaine lettuce, fresh tomatoes, crispy chicken, croutons, hard-boiled egg, Parmesan, sweetcorn and Caesar dressing

Lechuga romana, tomate natural, crujiente de pollo, costrones de pan, huevo duro, Parmesano, maíz y salsa César

13,5

LUNGOMARE

Mix di lattughe, pomodorini secchi idratati, code di gamberi, carciofi, tonno, salmone, peperone rosso, indivia e filetti d'acciuga

Mixed lettuce leaves, hydrated sun-dried tomatoes, king prawn tails, artichokes, tuna, salmon, red pepper, chicory and anchovy fillets

Variado de lechugas, tomate seco hidratado, colas de langostinos, alcachofas, atún, salmón, pimienta roja, endivias y filetes de anchoa

14,5

OLONA

Mix di lattughe, pomodorini Pachino confit, noci caramellate, rollè di caprino e guanciale, contorno di vinaigrette di piña colada

Mixed lettuce leaves, cherry tomato confit, caramelised walnuts, goat's cheese and guanciale, served with a piña colada vinaigrette

Variado de lechugas, tomate cherry confitado, nueces caramelizadas, queso rulo de cabra y guanciale, acompañada de vinagreta de piña colada

14

CAPRESE

Pomodoro, bocconcini di mozzarella, basilico fresco e olio di olive nere

Tomato, bocconcino mozzarella, fresh basil and black olive oil

Tomate, mozzarella de bocconcino, albahaca fresca y aceite de oliva negra

15

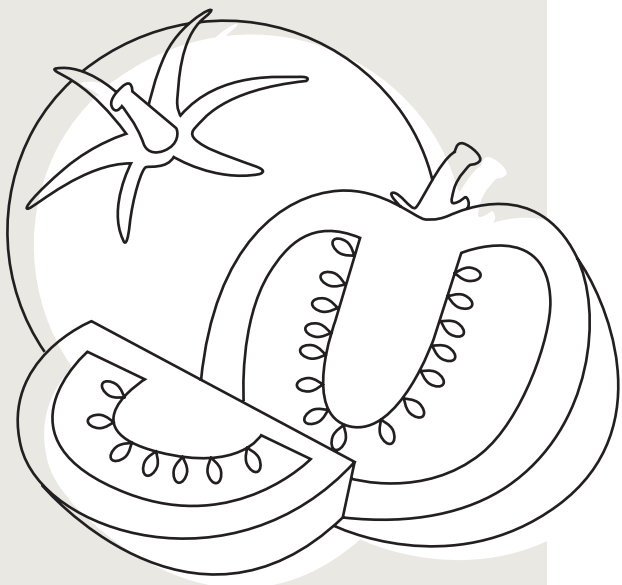

RISOTTI

GAMBERONI E FUNGHI

*Risotto con gamberetti, champignon
e olio al tartufo*

*Creamy rice with prawns, mushrooms
and truffle oil*

*Arroz cremoso con gambas, champiñones
y aceite de trufa*

15

VERDURA

*Risotto con zucchine, asparagi verdi,
broccoli, champignon e funghi*

*Creamy rice with courgettes, green
asparagus, broccoli, mushrooms and
wild mushrooms*

*Arroz cremoso con calabacín, espárragos
verdes, brócoli, champiñón y setas*

14

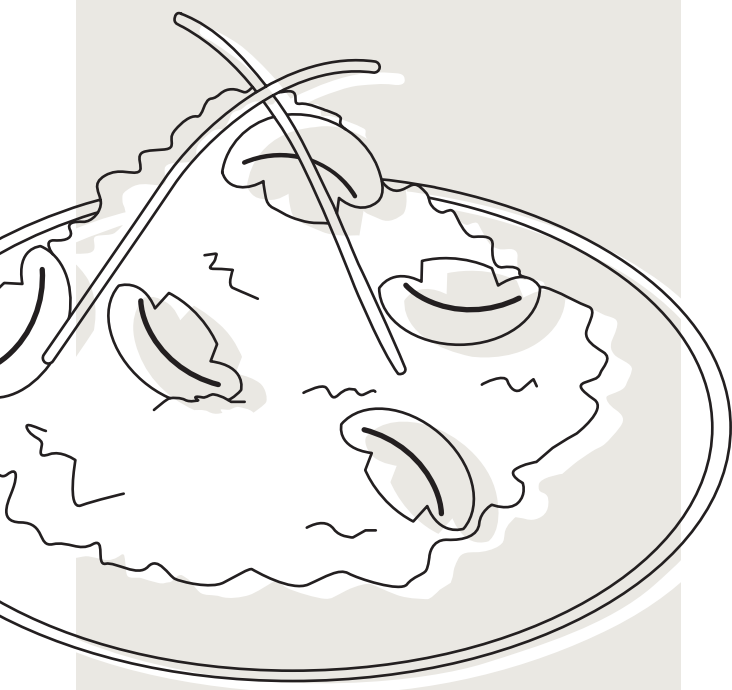

CAPOLAVORO

Risotto con ricotta, zafferano e salame piccante

Creamy rice with ricotta, saffron and spicy salami

Arroz cremoso con ricotta, azafrán y salami picante

16

AL GRATEN LASAGNE ALLA BOLOGNESE

Lasagne alla bolognese

Lasagne bolognese

Lasaña a la boloñesa

16

CANNELLONI DI BROCCOLI, PATATA E SALCICCIA

Cannelloni di broccoli, patate salsiccia

Broccoli, potato and sausage cannelloni

Canelones de brócoli, patata y salchicha

15

PARMIGIANA DI MELANZANE

Parmigiana di melanzane

Aubergine Parmigiana

Parmigiana de berenjenas

14,5

PASTA

PACCHERI

Con ragù di polpo e pomodori confit

With octopus ragu and tomato confit

Con ragut de pulpo y tomate confitado

17

TAGLIATELLE

All'astice

With lobster

Con bogavante

24

PENNE RIGATE

All'arrabiata

All'arrabiata

All'arrabiata

13,5

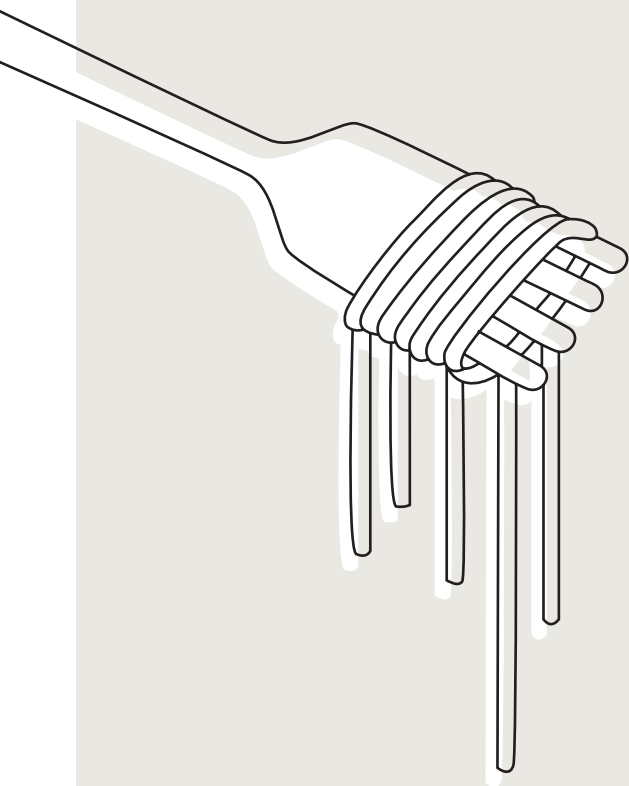



ORECCHIETTE

Con gamberetti e funghi

With wild mushrooms and prawns

Con setas y gambas

15,5

CASERECCE

Alle verdure

With vegetables

Con verdura

14

GNOCCHI

Con mozzarella e melanzane

With aubergine and mozzarella

Con berenjena y mozzarella

15

SPAGHETTI

Al nero di seppia

With cuttlefish

Nero di seppia

14,5

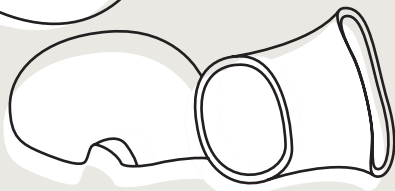
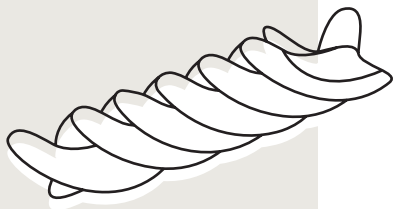

P I Z Z E

PRIMAVERA

Mix di verdure, champignon, pomodoro fresco a fette e spezie

Mixed vegetables, mushrooms, sliced fresh tomato and spices

mixto de verduras, champiñones, tomate en rodaja fresco y especias

15,5

SAN REMO

Pomodoro, mozzarella, funghi, gamberetti, Parmigiano e tonno

Tomato, mozzarella, wild mushrooms, prawns, Parmesan and tuna

Tomate, mozzarella, setas, gambas, Parmesano y atún

15

TRAMONTANA

Pomodoro, mozzarella, peperoni, prosciutto cotto, peperone rosso, champignon e stracchino

Tomato, mozzarella, pepperoni, cooked ham, red pepper, mushrooms and stracchino cheese

Tomate, mozzarella, peperoni, jamón york, pimienta rojo, champiñón y queso stracchino

14,5

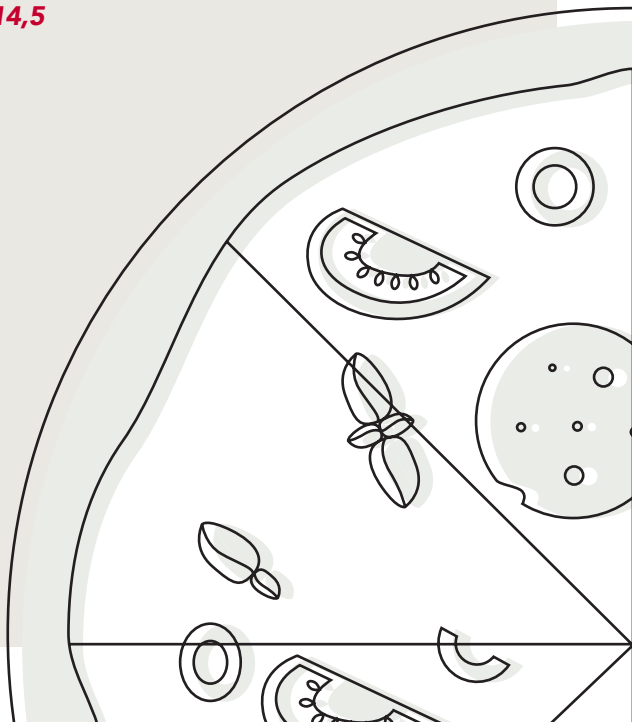

DIAVOLA

Pomodoro, mozzarella, peperoni, peperoncino, parmigiano, salsiccia e stracchino

Tomato, mozzarella, pepperoni, hot chilli peppers, sausage and stracchino cheese

Tomate, mozzarella, peperoni, peperoncino, parmigiano, longaniza y queso stracchino

15,5

CINQUE FORMAGGI

Pomodoro, mozzarella, emmental, Groviera, Parmigiano e Gorgonzola

Tomato, mozzarella, emmental, Gruyère, Parmesan and Gorgonzola

Tomate, mozzarella, emmental, Gruyer, Parmesano y Gorgonzola

15

SALMONE E GAMBERI

Pomodoro, mozzarella, salmone, acciughe, gamberetti

Tomato, mozzarella, salmon, anchovies, prawns

Tomate, mozzarella, salmon, anchoas, gambas

16,5

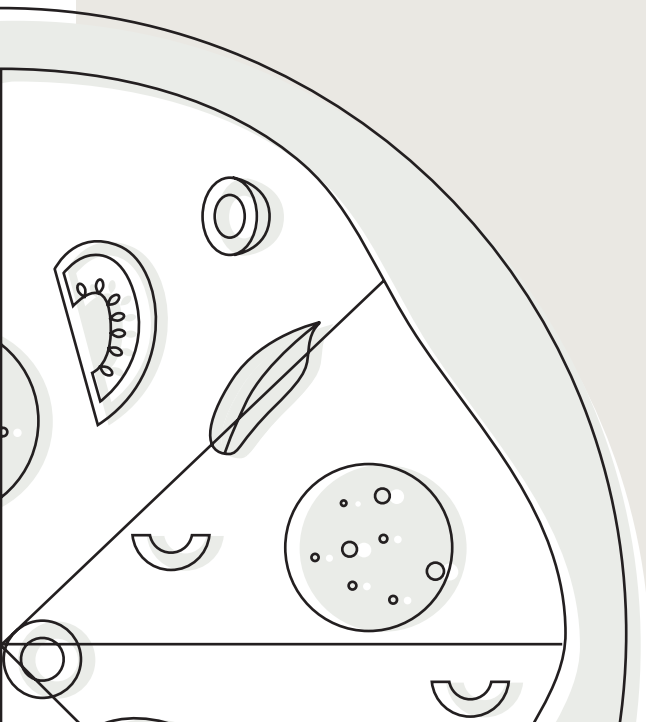

BIANCA BRESAOLA E RUCOLA

*Mozzarella, carne essiccata, rucola
e olio d'oliva*

*Mozzarella, cured meat, rocket and
olive oil*

Mozzarella, cecina, rúcula y aceite de oliva
14,5

BOSCAIOLA

Pomodoro, mozzarella, pancetta e funghi

*Tomato, mozzarella, pancetta and
wild mushrooms*

Tomate, mozzarella, panceta y setas
14

CALZONE CAPOLAVORO

*Pizza chiusa con pomodoro, mozzarella,
uova, champignon, prosciutto crudo e pepe*

*Calzone with tomato, mozzarella, egg,
mushrooms, serrano ham and pepper*

*Pizza cerrada con tomate, mozzarella, huevo,
champiñones, jamón serrano y pimienta*
16

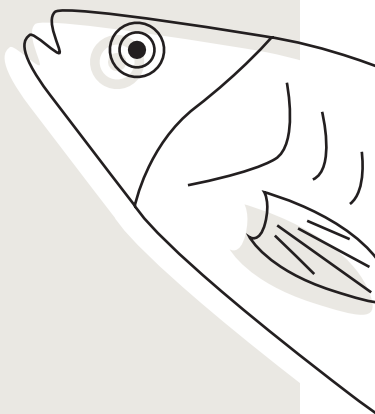

P E S C E

BACCALÀ ALLA CROSTA

Con maionese di verdure

Cod baked in a crust with a vegetable mayonnaise

Bacalao encostrado con mayonesa de verduras

20

SALMONE ARROTOLATO

Rollè di salmone con spumone di patate e barbabietole

Salmon roulade with potato and beetroot foam

Enrollado de salmón con espuma de patata y remolacha

22

QUADRATI DI TONNO

Trancio di tonno alla griglia con polenta liquida

Grilled tuna tacos with creamy polenta

Taqueado de atún a la plancha con polenta líquida

21

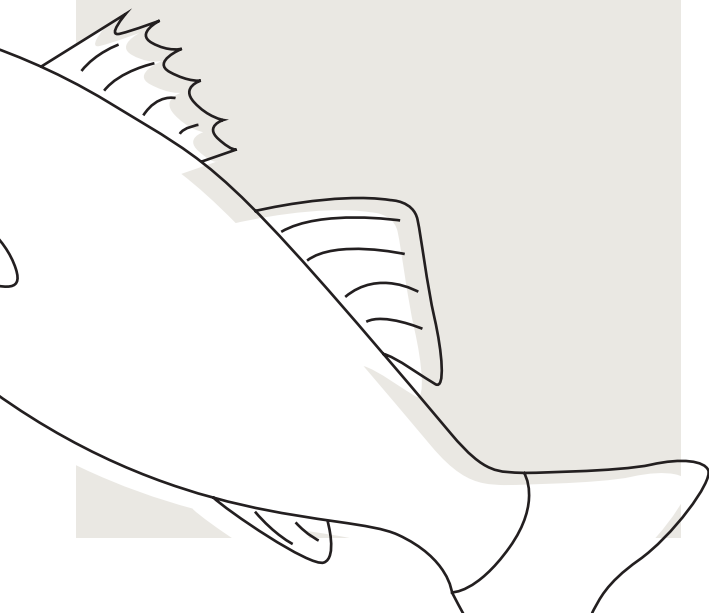

C A R N E

SALTINBOCCA ALLA ROMANA

*Filetto di maiale in salsa,
con prosciutto italiano e salvia*

*Pork fillet in its own juices,
with Italian ham and sage*

*Solomillo de cerdo en su jugo,
con jamón italiano y salvia*

19

OSSOBUCO AL TARTUFO NERO

Contorno di tagliatelle

Served with tagliatelle

Acompañado de tagliatelle

20

TAGLIATA DI MANZO

Entrecot di vitello con Parmigiano e rucola

Beef sirloin steak with Parmesan and rocket

Entrecot de ternera con Parmesano y rúcula

23

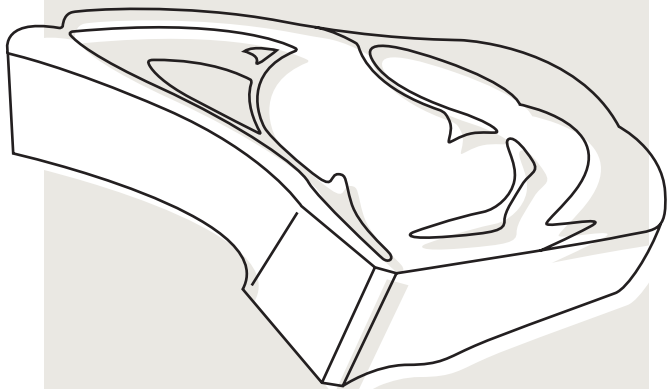

D O L C I

CANNOLI

Ripieni di ricotta con salsa di vaniglia

*Filled with ricotta and served with
a vanilla sauce*

Relleno de ricotta con salsa de vainilla

9,5

TIRAMISÙ CAPOLAVORO

7,5

PANNA COTTA

Alla vaniglia e frutti rossi

Vanilla panna cotta with forest fruits

Panna cotta de vainilla y frutos rojos

7,5

SEMIFREDDO

*Al mango con praline di lime e sorbetto
di mela verde*

*Mango semifreddo with lime pearls and
a green apple sorbet*

*Semifrio de mango con perlas de lima
y sorbete de manzana verde*

8,5

TORTA

Ricotta pere e noci

Ricotta and pear tart with walnuts

Tarta de ricotta y pera con nueces

8

GELATI ITALIANI

Selezione di gelati italiani tradizionali

Selection of traditional italian ice creams

Selección de helados tracidionales italianos

7,5

B A M B I N I

PIZZA MARGHERITA

Pomodoro e mozzarella

Tomato and mozzarella

Tomate y mozzarella

9

PIZZA PROSCIUTTO

Pomodoro, mozzarella e prosciutto cotto

Tomato, mozzarella and cooked ham

Tomate, mozzarella y jamón de york

10

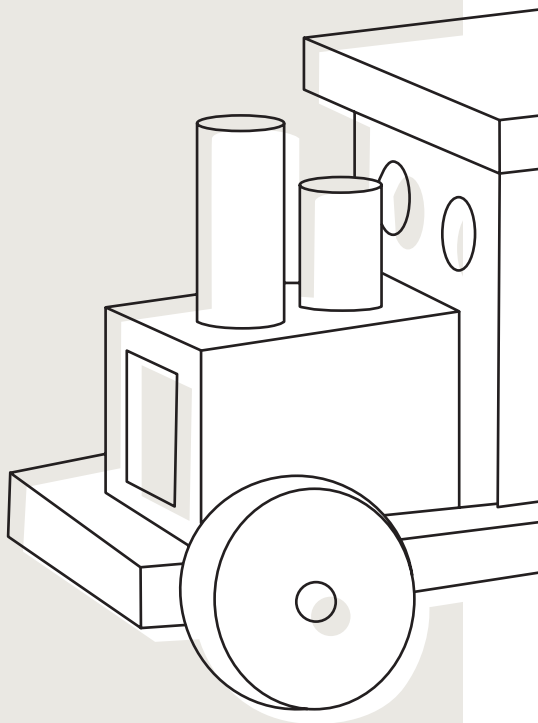

**SPAGHETTI
O PENNE RIGATE**

Con sugo alla napoletana o alla bolognese

With neapolitan or bolognese sauce

Con salsa napolitana o boloñesa

9,5

**CANNELLONI
ALLA BOLOGNESE**

Cannelloni alla bolognese

Cannelloni bolognese

Canelones a la boloñesa

10,5

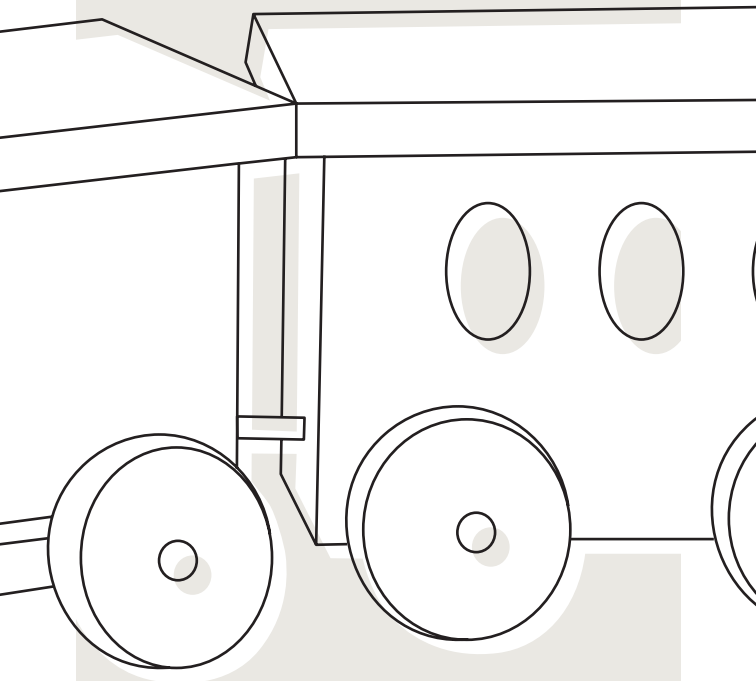

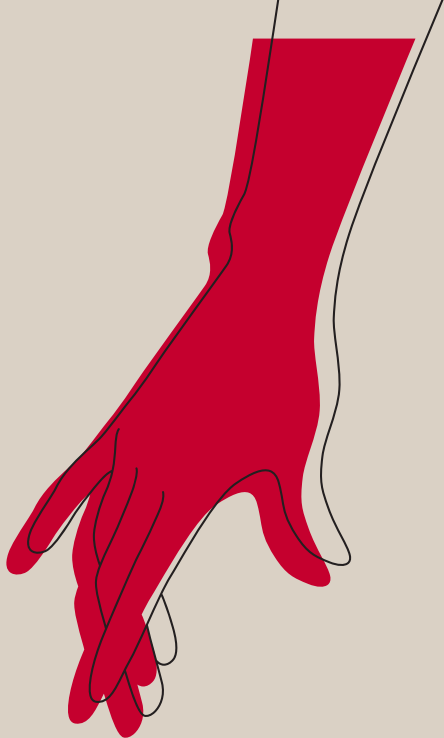

ITALIA
CAPOLAVORO
Amore mio

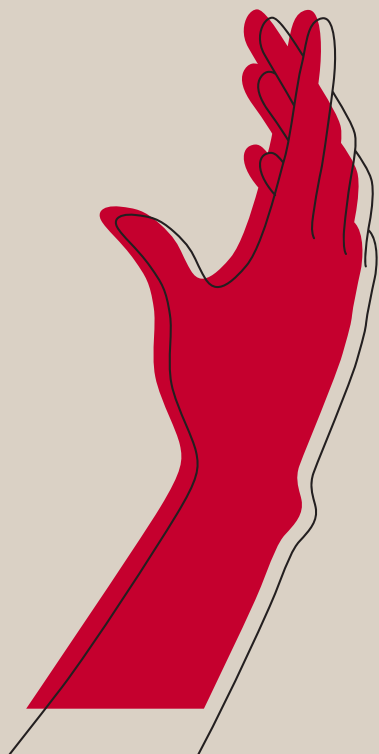

ITALIA
CAPOLAVORO
Amore mio

CHAMPAGNE

SPARKLING WINE

VINO ESPUMOSO

MOËT & CHANDON

Brut Impérial

 **16**  **90**

MOËT & CHANDON

Rosé

 **19**  **105**

MOËT & CHANDON

Ice Impérial

 **130**

VEUVE CLICQUOT

Yellow Label Brut

 **95**

VEUVE CLICQUOT

Rosé

 **120**

DOM PÉRIGNON

Vintage Brut

 **290**

DOM PÉRIGNON

Vintage Rosé

 **550**

RUINART BLANC DE BLANCS

Brut

 **135**

RUINART

Rosé

 **145**

KRUG GRAND CUVÉE

Brut

 **340**

LOUIS ROEDERER CRISTAL

Vintage Brut

 **375**

*All prices are established in euros - IGIC included
Todos los precios están establecidos en euros - IGIC incluido

If you have any food allergies or intolerances, ask our staff
Si usted tiene alguna alergia o intolerancia consulte con nuestro personal

SPUMANTE

SPARKLING WINES

ESPUMOSOS

SPUMANTE ROSÉ EXTRA DRY MASCHIO DEI CAVALIERI

Pinot bianco, pinot nero y raboso.

Veneto

 4  20

PROSECCO TREVISO DOC EXTRA DRY MASCHIO DEI CAVALIERI

Glera. Veneto

 5,5  24

GL'OR PINOT GRIGIO DELLE VENEZIE DOC SPUMANTE EXTRA DRY

Pinot Grigio. Veneto

 28

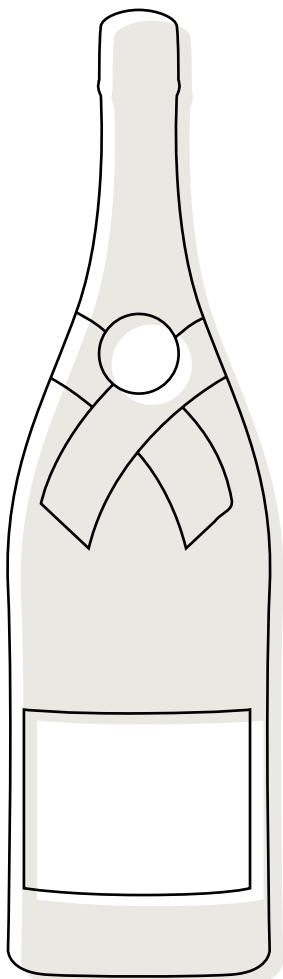

**VINI
BIANCHI
SPAGNA**
SPANISH WHITE WINES
VINOS BLANCOS ESPAÑA

TAJINASTE SECO

Listán Blanco, Moscatel
Islas Canarias

 **5**  **26**

EL GRIFO MALVASÍA SECO

Malvasía volcánica
Lanzarote

 **31**

PAISAJE DE LAS ISLAS

Malvasía aromática, Marmajuelo
Islas Canarias

 **32**

EL IDILIO GRAN FEUDO

Chardonnay
Navarra

 **4,5**  **24**

MUGA

Viura, Malvasía
Rioja

 **26**

HABLA DE TI

Sauvignon Blanc
Extremadura

 **28**

PAZO DE SEÑORANS

Albariño
Rías Baixas

 **29**

*All prices are established in euros - IGIC included
Todos los precios están establecidos en euros - IGIC incluido

If you have any food allergies or intolerances, ask our staff
Si usted tiene alguna alergia o intolerancia consulte con nuestro personal

**VINI
BIANCHI
ITALIA**
ITALIAN WHITE WINES
VINOS BLANCOS
ITALIA

TOR DEL COLLE

*Sauvignon Trevenezie
Veneto*

 **5**  **24**

LA VIS ecológico

*Pinot Grigio
Trentino*

 **26**

**GAVI DI GAVI DOCG GRANÉE
BATASIOLO**

*Cortese
Piemonte*

 **28**

**GRECO DI TUFO DOCG
VESEVO**

*Greco
Campania*

 **32**

WINKL

TERLAN

*Sauvignon
Alto Adige*

 **38**

VINI ROSÉ
SPAGNA
SPANISH ROSÉ WINES
ROSADOS ESPAÑA

EL GRIFO
Listán Negro
Lanzarote



BALUARTE
Garnacha
Rioja



ROSÉ
RESTO DEL
MONDO
ROSÉ WINES
OF THE WORLD
ROSADOS
RESTO DEL MUNDO

BLUSH
LAMBERTI
Pinot Grigio
Veneto



11 MINUTES
PASQUA
Corvina, Trebbiano, Syrah, Carménère
Veneto



*All prices are established in euros - IGIC included
Todos los precios están establecidos en euros - IGIC incluido

If you have any food allergies or intolerances, ask our staff
Si usted tiene alguna alergia o intolerancia consulte con nuestro personal

VINI ROSSI

RED WINES

VINOS TINTOS

TAJINASTE TRADICIONAL

Listán Negro
Valle de la Orotava

 5  27

CRATER CRIANZA

Listán Negro, Negramoll,
Tacoronte Acentejo

 38

VIÑA SALCEDA CRIANZA

Tempranillo, Graciano y Mazuelo
Rioja

 4,5  24

MUGA

Tempranillo, Garnacha y Graciano
Rioja

 33

CONDE SAN CRISTOBAL

Tinta fina
Ribera del Duero

 28

TERMES

Tinta de Toro
Toro

 41

VINI ROSSI
RESTO DEL
MONDO
RED WINES
OF THE WORLD
VINOS TINTOS
RESTO DEL MUNDO

LAMBRUSCO GRASPAROSSA
IL FOJONCO
RIUNITE
Lambrusco
Emilia Romagna

 **4**  **18**

OTELLO 1813 NERO DI LAMBRUSCO
CECI
Lambrusco
Emilia Romagna

 **25**

VALPOLICELLA CLASSICO
MASI
Corvina, Rondinella y Molinara
Veneto

 **28**

MERLOT TRENTINO
LA VIS
Merlot
Trentino

 **5**  **25**

CHIANTI CLASSICO
BANFI
Sangiovese, Merlot
Toscana

 **29**

*All prices are established in euros - IGIC included
Todos los precios están establecidos en euros - IGIC incluido

If you have any food allergies or intolerances, ask our staff
Si usted tiene alguna alergia o intolerancia consulte con nuestro personal

**BAROLO
BATASIOLO**
Nebbiolo
Piemonte



**LE DIFESE TOSCANA IGT
TENUTA SAN GUIDO (Sassicaia)**
Cabernet, Sangiovese
Toscana



**CHIANTARI NERO D'AVOLA
VIGNETI ZABÙ**
Nero d'Avola
Sicilia



**ZOLLA PRIMITIVO DI MANDURIA
VIGNETI DEL SALENTO**
Primitivo
Puglia



**AMARONE
DELLA VALPOLICELLA CLASSICO
MASI**
Corvina, Rondinella y Molinara
Veneto



BIRRE

BEERS
CERVEZAS

HEINEKEN

 **4**  **5,5**

HEINEKEN 0,0

 **4**

DESPERADOS

 **5**

CRUZCAMPO GRAN RESERVA

 **5**

BIRRA MORETTI

 **5**

ICHNUSA NON FILTRATA

 **6**

CRUZCAMPO

(Gluten free - sin gluten)

 **5**

*All prices are established in euros - IGIC included
Todos los precios están establecidos en euros - IGIC incluido

If you have any food allergies or intolerances, ask our staff
Si usted tiene alguna alergia o intolerancia consulte con nuestro personal

APERITIVI

APERITIFS
APERITIVOS

CARPANO

Bianco, Rosso y Dry
Italia



LILLET

Bianco
Francia



MARTINI

Bianco, Rosso y Dry
Italia



PERNOD



RICARD



CAMPARI



BIBITE SOFT DRINKS REFRESCOS

VILAS DEL TURBÓN WATER

Still water - Agua sin gas

3,5 4,5

AQUABONA SINGULAR SPARKLING WATER

Agua con gas. 365 ml

 **3,5**

SAN PELLEGRINO SPARKLING WATER

Agua con gas. 500 ml

 **4**

APPLETISER

 **3,5**

FANTA

Lemon Orange - Limón Naranja

 **3,5**

COCA-COLA | LIGHT | ZERO

 **3,5**

SPRITE | NESTEA | NORDIC MIST

 **3,5**

ROYAL BLISS

Orange, Lemon, Zero, Yuzu,
Ginger Ale, Berry, Soda
Naranja, Limon, Zero, Yuzu,
Ginger Ale, Berry, Soda

 **5**

AQUARIUS

Lemon Orange - Limón Naranja

 **3,5**

MARE ROSSO

Bitter Rosso

 **3,5**

*All prices are established in euros - IGIC included
Todos los precios están establecidos en euros - IGIC incluido

If you have any food allergies or intolerances, ask our staff
Si usted tiene alguna alergia o intolerancia consulte con nuestro personal

RED BULL

(Regular, Sugar Free, The Tropical,
Red, Lime & Tropical Edition)

 **4,5**

MINUTE MAID

Selection - Duofrutas

 **3,5**

FRESHLY SQUEEZED ORANGE JUICE

Fresh orange juice / Zumo de naranja natural

 **5,5**

COCKTAILS

COCKTAILS

CÓCTELES

TRAMONTO A CAPRI

Vodka Orange, Limoncello, Aperol,
Gomme Syrup and Orange juice

Vodka naranja, Limoncello, Aperol,
Gomme Syrup y Zumo de naranja

 **10**

BOHEMIAN SICILY

Martini bianco, Cherry brandy,
Grapefruit juice and Royal Bliss berry

Martini bianco, Cherry brandy,
Zumo de pomelo y Royal Bliss berry

 **10**

O SOLE MIO

Drambuie, Dry Martini,
Fernet Branca and Dry Gin

Drambuie, Martini Dry,
Fernet Branca y Dry Gin

 **10**

MIA BELLA MADONNINA

Berry smoothie, Dom Benedictine,
Grapefruit juice and Prosecco

Berry pureé, Dom Benedictine,
Zumo de pomelo y Prosecco

 **10**

GARIBALDI

Campari, Gomme Syrup and
Orange juice

Campari, Gomme Syrup y
Zumo de naranja

 **10**

VODKA

STOLI

🍸9 🍷90

BELVEDERE

🍸12 🍷130

**BELVEDERE
INTENSE UNFILTERED**

🍸14 🍷140

GIN GIN GINEBRA

LARIOS 12

🍸10 🍷100

LARIOS 12 ROSÉ

🍸10 🍷100

ROKU

🍸11 🍷110

SIPFMITH

🍸11 🍷110

BOMBAY

🍸10 🍷100

BOMBAY SAPPHIRE

🍸11 🍷110

STAR OF BOMBAY

🍸12 🍷130

HENDRICK'S

🍸12 🍷130

MARTIN MILLERS

🍸11 🍷120

GIN MARE

🍸12 🍷130

*All prices are established in euros - IGIC included
Todos los precios están establecidos en euros - IGIC incluido

If you have any food allergies or intolerances, ask our staff
Si usted tiene alguna alergia o intolerancia consulte con nuestro personal

RUM

RUM
RON

BRUGAL EXTRA DRY

🍸10 🍷100

BRUGAL AÑEJO

🍸10 🍷100

BRUGAL 1888

🍸15 🍷160

BRUGAL XV

🍸12 🍷120

ZACAPA 23 Y

🍸16 🍷160

ZACAPA XO

🍸21 🍷220

RON MIEL

🍸7 🍷70



WHISKY

MAKER'S MARK

🍷11 🍷110

JIM BEAM

🍷10 🍷100

JIM BEAM DOUBLE OAK

🍷11 🍷110

JOHNNIE WALKER RED LABEL

🍷10 🍷100

JOHNNIE WALKER BLACK LABEL

🍷12 🍷120

HIBIKI 12Y

🍷22 🍷250

TEQUILA & MEZCAL

CASAMIGOS BLANCO

🍷9 🍷100

CASAMIGOS REPOSADO

🍷11 🍷120

CASAMIGOS AÑEJO

🍷12 🍷130

DON JULIO BLANCO

🍷11 🍷110

DON JULIO REPOSADO

🍷12 🍷120

EL JIMADOR BLANCO

🍷9 🍷90

EL JIMADOR REPOSADO

🍷10 🍷100

*All prices are established in euros - IGIC included
Todos los precios están establecidos en euros - IGIC incluido

If you have any food allergies or intolerances, ask our staff
Si usted tiene alguna alergia o intolerancia consulte con nuestro personal

LIQUORI

SPIRITS
LICORES

AMARETTO DISARONNO

🍸6 🍷65

BAILEYS

🍸6 🍷65

COINTREAU

🍸6 🍷65

FIREBALL

🍸6 🍷65

GRAND MARNIER

🍸6 🍷65

LICOR 43

🍸6 🍷65

FERNET

🍸6 🍷65

LIMONCELLO AMALFI

🍸6 🍷65

PASSOÃ

🍸6 🍷65



